

Fittings for catering equipment

Drain taps	page 1088
Inlet taps	page 1093
Inlet spouts	page 1097
Steam taps	page 1099
Anti-vacuum valves	page 1099
Test taps	page 1100
Safety fittings	page 1100
Built in safety fittings	page 1102
Safety fittings with lid	page 1102
Safety valves	page 1103
Steam traps	page 1103
Lid hinges	page 1104
Lid locks (Autoclave)	page 1109

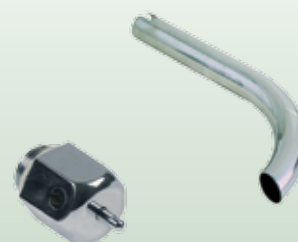

drain taps

ECHTERMANN

BG-certified, nickel silver

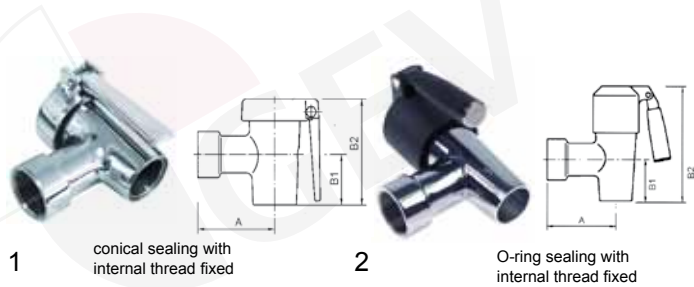

fig.	order no.	connection	A (mm)	B1 (mm)	B2 (mm)
1	540135	1"	80	42	102
1	540136	1¼"	90	47	112
1	540137	1½"	100	52	125
1	540138	2"	120	65	148
2	541931	1½"	100	65	185
2	541932	2"	120	70	202

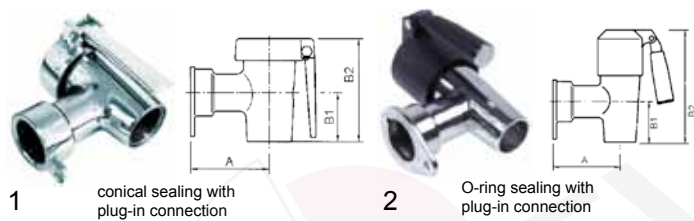

fig.	order no.	nominal size	pipe ø(mm)	A (mm)	B1 (mm)	B2 (mm)
1	540155	1½"	47	100	52	125
1	540156	2"	59	120	65	148
2	541437	1½"	47	100	65	185
2	541438	2"	59	120	70	202

spare parts and accessories

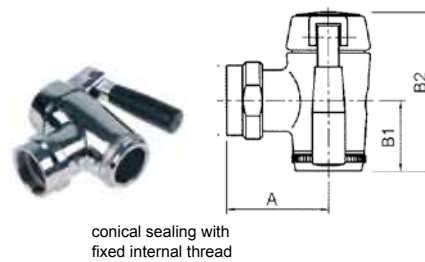

fig.	order no.	description	for drain tap
1	541531	repair kit with 4xO-ring + fitting grease	541437
1	541532	repair kit with 4xO-ring + fitting grease	541438
2	541933	plastic cap with handle	541931-932 541437-438
3	541934	rosette for 1" thread	540135
3	541935	rosette for 1¼" thread	540136
3	541936	rosette for 1½" thread	540137 541931
3	541937	rosette for 2" thread	540138 541932



fig.	order no.	description	for drain tap
1	540083	pressure bolt	540135-138 540155-156
2	540081	handle 90mm	540135
2	540082	handle 110mm	540136-138 540155-156
3	540222	O-ring 2.62x47.30	540155
3	540119	O-ring 2.50x59.00	540156

ECO-STAR



no.	order no.	connection	A (mm)	B1 (mm)	B2 (mm)
1	541941	1½"	80	55	124
2	541591	2"	110	68	145

FRIULI

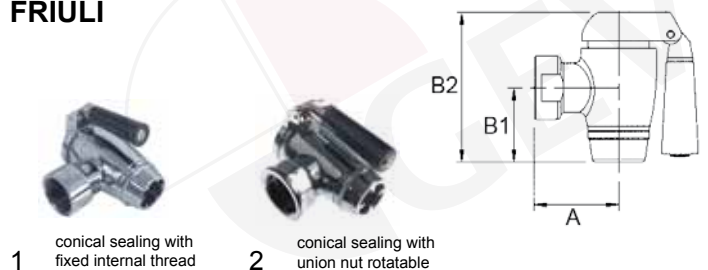

fig.	order no.	connection	A (mm)	B1 (mm)	B2 (mm)
1	541938	¾"	65	42	98
1	540130	1"	62	51	95
1	540131	1¼"	95	75	140
1	540132	1½"	95	75	140
1	540134	2"	115	85	165
2	541939	1½"	95	75	140
2	540275	2"	88	85	150



fig.	order no.	connection	A (mm)	B1 (mm)	B2 (mm)
1	540925	1½"	85	68	130
2	548001	1½"	85	68	130
3	541630	2"	92	74	160

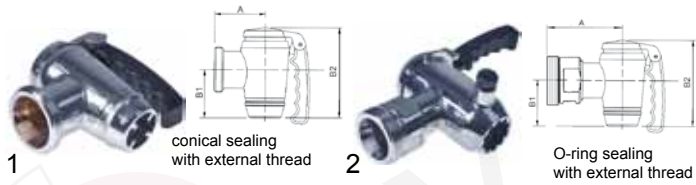

fig.	order no.	thread	pipe ø(mm)	A	(mm) B1	B2	suitable for:	ref. no.
1	540157	M78x3	50	88	83	155	Alpeninox Zanussi	OS0138 053159
2	540296	M60x2	37	105	70	130	Alpeninox Zanussi	OS0112 017215
2	540298	M68x3	40	105	70	130	Alpeninox Zanussi	OS0137 052907



fig.	order no.	description	A	B	C
1	541942	rosette 1"	33	72	8
1	541943	rosette 1¼"	44	80	10
1	541944	rosette 1½"	49	80	10
1	540958	rosette 2"	60	120	13
2	540956	fibre gasket 1½"			
2	540959	fibre gasket 2"			

spare parts and accessories



fig.	order no.	description	for drain tap
1	540212	handle for 1" drain tap	540130 541938
2	540213	handle for 1¼"/1½" drain tap	540131 540132 540925 548001 540296 540298 541939
2	540214	handle for 2" drain tap	540134 540275 541630 540157
3	540463	nut for 1" drain tap	540130
3	540464	nut for 1¼"/1½" drain tap	540131 540132
3	540465	nut for 2" drain tap	540134



fig.	order no.	description	for drain tap
1	540460	ring for 1" drain tap	540130
1	540461	ring for 1¼"/1½" drain tap	540131 540132
1	540462	ring for 2" drain tap	540134
2	505092	O-ring 5.34x43.82	540925 548001 540296 540298
2	505517	O-ring 5.34x53.65	541630



no.	order no.	description	length (mm)
1	541945	screw-in socket 1"	80
2	541946	screw-in socket 1¼"	80
3	541947	screw-in socket 1½"	80
4	541948	screw-in socket 2"	80

lubricants

fitting grease (KTW approved)



fig.	order no.	description	bundle
1	890087	silicone grease	collapsible tube 25g
1	890101	silicone grease	collapsible tube 75g
2	890237	fitting grease	collapsible tube 20g



fig.	order no.	description	bundle
1	890119	fitting grease	collapsible tube 25g
2	890118	fitting grease	can 1000g
3	890116	fitting grease	collapsible tube 60g

drain taps



fig.	order no.	connection	A (mm)	B (mm)
1	540685	3/4"	46	40
2	541540	3/4"	38	40



fig.	order no.	connection	A (mm)	B (mm)
1	540747	1/2"	30	40
1	540699	3/4"	38	38
2	540260	1"	43	40



fig.	order no.	connection	A (mm)	suitable for
1	514207	3/4"	84	Bertos
2	540763	3/4"	84	MBM Olis
2	540776	3/4"	84	Modular

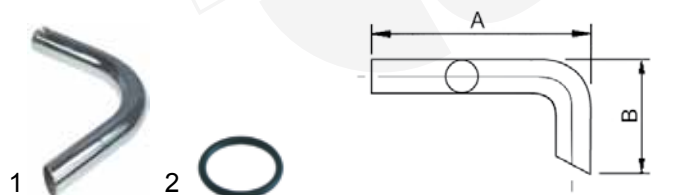

fig.	order no.	pipe ø	A (mm)	B (mm)
1	540651	22	130	150
1	540734	22	145	50
1	514006	22	190	100
2	532453	O-ring EPDM ø2.62x21.89		



fig.	order no.	description	for drain tap
1	691355	thread bolt M6	540763
2	112934	plastic handle M6	
3	110734	lever	540776
4	514217	lever	

drain taps various



fig.	order no.	description	suitable for	ref. no.
1	540730	drain tap 3/4"	Angelo Po	33D0170
2	540681	drain pipe 97mm	Angelo Po	36D4070
3	540684	drainage elbow	Angelo Po	33Q5020
4	540683	hole cover	Angelo Po	36D4080
5	540682	O-ring	Angelo Po	3150840

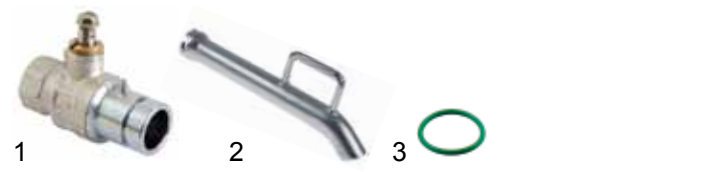

fig.	order no.	description	suitable for	ref. no.
1	540689	drain tap 3/4"	Angelo Po	33D1770
2	541530	drain pipe	Angelo Po	3AZ0090
3	532487	O-ring	Angelo Po	3150690



fig.	order no.	description	suitable for	ref. no.
1	540759	drain tap 1"	Angelo Po	33D1760
2	514153	drain pipe	Angelo Po	3AZ0100
3	504561	O-ring	Angelo Po	3151080



fig.	order no.	description	suitable for	ref. no.
1	540658	drain tap 3/4"	Bertos	32686300
2	514280	extension	Bertos	32696300



fig.	order no.	description	suitable for	ref. no.
1	540751	drain tap 1"	Elframo	13110001
2	540752	extension 165mm	Elframo	00030450
2	540753	extension 400mm	Elframo	00030470



fig.	order no.	description	suitable for	ref. no.
1	540910	drain tap 3/4"	Forved	3118

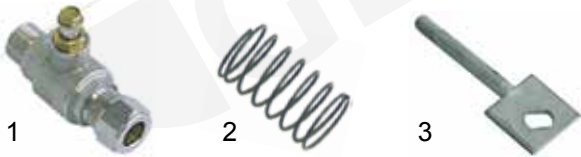

fig.	order no.	description	suitable for	ref. no.
1	540733	drain tap 1/2"	Gico	433206
2	540736	spring for lever handle	Gico	260201950
3	540735	lever	Gico	160103020

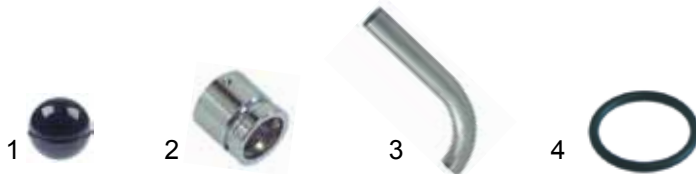

fig.	order no.	description	suitable for	ref. no.
1	514130	ball for lever	Gico	333302006
2	540746	adaptor for drain pipe	Gico	760103840
3	540734	drain pipe	Gico	760302430
4	532453	O-ring EPDM ø2.62x21.89	Gico	



fig.	order no.	description	suitable for	ref. no.
1	514212	drain tap 3/4"	Giga	0000X15300
2	514233	drain tap 3/4"	Giga	0000X15200
3	540651	drain pipe	Giga	
4	514410	lever	Giga	T30200
5	514411	handle for lever	Giga	M22200



fig.	order no.	description	suitable for	ref. no.
1	540750	drain tap 3/4"	Lotus	531001000
2	540259	drain tap 3/4"	Lotus	531000100
3	540748	lever 70mm	Lotus	533027200
4	691355	lever 64mm	Lotus	533009600



fig.	order no.	description	suitable for	ref. no.
1	112934	plastic handle	Lotus	536000300
2	514006	drain pipe	Lotus	544120300
3	106597	union screw 3/4"	Lotus	533010100
4	106598	cutting ring	Lotus	533010200

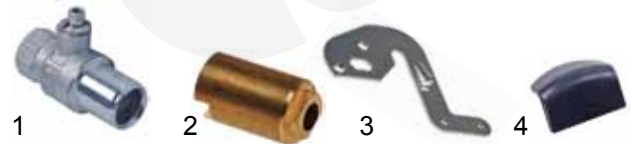

fig.	order no.	description	suitable for	ref. no.
1	540776	drain tap 3/4"	Mareno	1040424
2	691356	shaft extension	Mareno	1033720900
3	691334	lever right	Mareno	1044235100
4	514015	lever handle	Mareno	1036702000



fig.	order no.	description	suitable for	ref. no.
1	514006	drain pipe	Mareno	1033300300
2	106597	union screw 3/4"	Mareno	866000
3	106598	cutting ring	Mareno	866200



fig.	order no.	description	suitable for	ref. no.
1	514005	drain tap 3/4"	Mareno	1031024110
2	691356	shaft extension	Mareno	1033720900
3	691333	lever left	Mareno	1044235200
4	514015	lever handle	Mareno	1036702000



fig.	order no.	description	suitable for	ref. no.
1	514325	drain tap 1" (83mm)	Mareno	1950700
2	514220	drain pipe	Mareno	012000
3	514219	drain pipe	Mareno	1577500



fig.	order no.	description	suitable for	ref. no.
1	540658	drain tap ¾"	Mareno	1450500
2	514050	lever 210mm	Mareno	1515500
2	514054	lever 245mm	Mareno	1959600
3	514051	plastic handle	Mareno	32000599



fig.	order no.	description	suitable for	ref. no.
1	540977	drain tap ¾"	Zanussi	056114
2	540927	drain tap 1"	Zanussi	056885

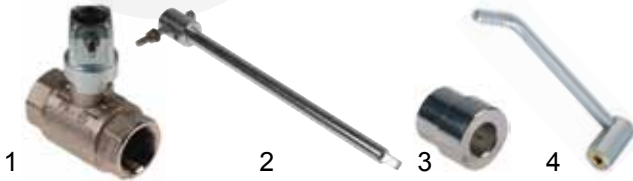

fig.	order no.	description	suitable for	ref. no.
1	514097	drain tap 1"	Mareno	CR0412260
2	514098	lever 220mm	Mareno	CM149101
3	514099	centering bush	Mareno	1515900
4	514059	lever handle	Mareno	CM155200



fig.	order no.	description	suitable for	ref. no.
1	540929	lever handle shaft 8x8	Zanussi	056887
2	540928	handle rod 8x8, 190mm	Zanussi	056985
3	514176	handle rod 165mm	Zanussi	
4	540979	handle rod 200mm	Zanussi	003377
4	514069	handle rod 335mm	Zanussi	002881
4	514070	handle rod 525mm	Zanussi	005770
4	514072	handle rod 530mm	Zanussi	002880
4	514068	handle rod 640mm	Zanussi	002883
5	540978	support plate	Zanussi	003378



fig.	order no.	description	suitable for	ref. no.
1	540776	drain tap ¾"	Mareno	1040424
2	514006	drain pipe	Mareno	1033300300
3	514074	drain tap ½"-¾"	MBM	160214



fig.	order no.	description	suitable for	ref. no.
1	514067	handle rod 575mm	Zanussi	056567
2	514324	lever rod M6, 81mm	Zanussi	055352
3	514322	handle M6	Zanussi	029898



fig.	Bestell no.	description	suitable for	ref. no.
1	520378	drain tap ¾"-½"	MKN	201092
2	520376	drain pipe ½"	MKN	205252



fig.	order no.	description	suitable for	ref. no.
1	514109	handle rod	Zanussi	003830
2	111666	star handle 7x7	Zanussi	010142
3	540978	support plate	Zanussi	003378



fig.	order no.	description	suitable for	ref. no.
1	540759	drain tap 1"	Olis	A023020
2	541529	drain pipe	Olis	9000619
3	540761	drain pipe	Olis	8217500
4	504561	O-ring	Olis	8217550



fig.	order no.	connection	suitable for	ref. no.
1	540964	drain tap ½"	Zanussi	058647
2	540975	drain tap ½"	Zanussi	058610
3	540976	drain pipe 80mm	Zanussi	004505
4	540965	drain pipe	Zanussi	002457

inlet taps



fig.	order no.	description	suitable for	ref. no.
1	514048	inlet tap 1/2" complete	Lotus	531018500
2	540871	handle with rosette	Lotus	



fig.	order no.	description	suitable for	ref. no.
1	514049	inlet tap 3/4" complete	Lotus	531020800



fig.	order no.	description	suitable for	ref. no.
1	540700	inlet tap 1/2"	Emmepi Giorik	808037 7060018
2	540701	handle	Emmepi Giorik	808432 2001250



fig.	order no.	description	suitable for	ref. no.
1	514266	inlet tap 3/8"	MBM Baron	168006 41826900960
2	514385	ball tap 3/8"	Angelo Po	3005990 33D3200



fig.	order no.	description	suitable for	ref. no.
1	514271	inlet tap 1/2" left	Baron	41853321537
1	514267	inlet tap 1/2" right	Baron	41826900070
2	514083	rosette 27x19	Baron	
3	514084	fastening nut 27x19	Baron	



fig.	order no.	description	suitable for	ref. no.
1	540930	inlet tap 1/2" left	Mareno	CM127800
1	540971	inlet tap 1/2" right	Mareno	
2	514083	rosette 27x19	Mareno	
3	514084	fastening nut 27x19	Mareno	



no.	order no.	description	suitable for	ref. no.
1	540773	inlet tap 1/2" left	Zanussi	003517 026537
2	540771	inlet tap 1/2" right	Zanussi	003516 025733



fig.	order no.	description	suitable for	ref. no.
1	540415	handle blue	Zanussi	
2	540414	handle red	Zanussi	
3	514083	rosette 27x19	Zanussi	
4	514084	fastening nut 27x19	Zanussi	



fig.	order no.	description	suitable for	ref. no.
1	540942	inlet tap 1/2" left, blue	Ambach	5018007357
2	540943	inlet tap 1/2" left, red	Ambach	5018003416 5018013782



fig.	order no.	description	suitable for	ref. no.
1	540924	tap head 1/2"	Ambach	5018007381
2	540951	handle	Ambach	5022913784
3	540944	rosette 26x19	Ambach	5022213783
4	540945	disc, blue	Ambach	5031400110
5	540946	disc, red	Ambach	5031400109
6	540947	cap cover	Ambach	5025000108
7	540948	screw M5x10	Ambach	5040913785



fig.	order no.	description	suitable for	ref. no.
1	514370	inlet tap 1/2"	Giga Star10	X18000 X18000
2	540415	handle, blue		
3	540414	handle, red		
4	514085	rosette 26x19		
5	514086	fastening nut 26x19		



fig.	order no.	description	suitable for	ref. no.
1	693107	inlet tap 1/2" blue	Lotus Fagor Firex Offcar	30200008 S112151000 30200008 FX30200008
2	514082	inlet tap 1/2" red		



fig.	order no.	description	suitable for	ref. no.
1	548169	handle, blue		
2	548168	handle, red		
3	514085	rosette 26x19		
4	514086	fastening nut 26x19		



fig.	order no.	description	suitable for	ref. no.
1	540656	inlet tap 1/2"	Silko	0102613 0100540
2	514085	rosette 26x19		
3	514086	fastening nut 26x19		



fig.	order no.	description	suitable for	ref. no.
1	540737	inlet tap 1/2"	Gico	790304640
2	540738	handle	Gico	790305070
3	514085	rosette 26x19		
4	514086	fastening nut 26x19		



fig.	order no.	description	suitable for	ref. no.
1	540941	inlet tap 1/2", blue	Ambach	5018007357
2	514091	inlet tap 1/2", red	Ambach	5018003416 5018013782



fig.	order no.	description	suitable for	ref. no.
1	540924	tap head 1/2"	Ambach	5018007381
2	540951	handle	Ambach	5022913784
3	540944	rosette 26x19	Ambach	5022213783
4	540945	disc, blue	Ambach	5031400110
5	540946	disc, red	Ambach	5031400109
6	540947	cap cover	Ambach	5025000108
7	540948	screw M5x10	Ambach	5040913785



fig.	order no.	description	suitable for	ref. no.
1	514102	inlet tap 3/4", blue	universal	
2	514103	inlet tap 3/4", red	universal	
3	514106	tap head 3/4", blue	universal	
4	514107	tap head 3/4", red	universal	



fig.	order no.	description	suitable for	ref. no.
1	514095	inlet tap 1/2" blue/red	universal	
2	547954	tap head 1/2"	universal	
3	547953	tap head, blue/red	universal	
4	547430	handle blue/red	universal	



fig.	order no.	description	suitable for	ref. no.
1	540891	inlet tap 1/2"-15mm red	universal	
2	540892	inlet tap 1/2"-15mm blue	universal	
3	540898	tap head 1/2", red	universal	
4	540899	tap head 1/2", blue	universal	



fig.	order no.	description	suitable for	ref. no.
1	514096	inlet tap 3/4" blue/red	universal	
2	547951	tap head 3/4"	universal	
3	547950	tap head, blue/red	universal	
4	547430	handle blue/red	universal	



fig.	order no.	description	suitable for	ref. no.
1	540894	inlet tap 3/4"-18mm red	universal	
2	540893	inlet tap 3/4"-18mm blue	universal	
3	540901	tap head red 3/4"	universal	
4	540900	tap head blue 3/4"	universal	



fig.	order no.	description	suitable for	ref. no.
1	514100	inlet tap 1/2", blue	universal	
2	514101	inlet tap 1/2", red	universal	
3	514104	tap head 1/2", blue	universal	
4	514105	tap head 1/2", red	universal	



fig.	order no.	description	suitable for	ref. no.
1	514269	inlet tap 1/2"-spout 100mm	Baron	826900260
1	540799	inlet tap 1/2"-spout 130mm	Zanussi	2322
2	548176	tap head 1/2"		
3	548171	handle blue		



fig.	order no.	description	suitable for	ref. no.
1	547503	inlet tap 1/2"	universal	
2	547707	tap head 1/2"	universal	
3	547713	handle blue	universal	
4	547712	handle red	universal	



fig.	order no.	description	suitable for	ref. no.
1	514052	inlet tap 1/2"-12mm	Mareno	1475300 700700
2	514244	tap head 1/2"	Mareno	955600
3	693081	handle blue	Mareno	832400



no.	order no.	description	suitable for	ref. no.
1	540660	inlet tap 12mm	Nayati	GS2305



fig.	order no.	description	suitable for	ref. no.
1	541429	inlet tap 1/2" blue/red	universal	
2	547952	inlet tap 3/4" blue/red	universal	

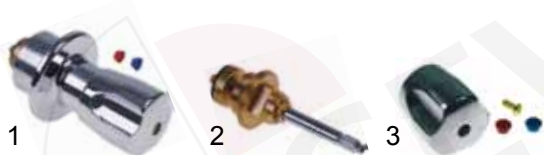

fig.	order no.	description	suitable for	ref. no.
1	547950	tap head 3/4" complete	universal	
2	547951	tap head 3/4"	universal	
3	547430	handle blue/red	universal	



fig.	order no.	description	suitable for	ref. no.
1	540690	inlet tap 3/8"	Angelo Po	33D0590
2	541813	handle blue	Angelo Po	36M2632
3	514383	handle red	Angelo Po	36M2641



fig.	order no.	description	suitable for	ref. no.
1	541817	inlet tap 1/2"	Angelo Po	33D2040
2	514090	handle blue/red	Angelo Po	36M4010 36M4030
3	541818	rosette 28x19	Angelo Po	



fig.	order no.	description	suitable for	ref. no.
1	540868	inlet tap with ceramic tap head	MBM	RTCP800018
2	514084	fastening nut 27x19		



fig.	order no.	description	suitable for	ref. no.
1	514355	mixer tap	Küppersbusch Thielmann	540830 144132
2	540312	tap head 3/4"		
3	547427	handle red/blue		



fig.	order no.	description	suitable for	ref. no.
1	540914	mixer tap	Juno	232270 232271

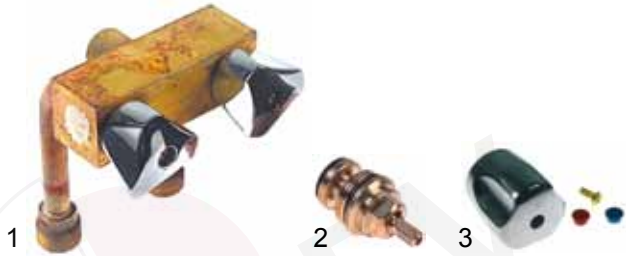

fig.	order no.	description	suitable for	ref. no.
1	540896	mixer tap	Küppersbusch Ascoblock	151603 8151603
2	540312	tap head 1/4"		
3	547427	handle red/blue		



fig.	order no.	description	suitable for	ref. no.
1	514396	outlet/drain/spout	universal	
2	548180	tap head 3/4"	universal	
3	540415	handle blue	universal	
4	540414	handle red	universal	

inlet spouts

turnable spouts



fig.	order no.	description	suitable for	ref. no.
1	540895	mixer tap	Küppersbusch	151602 150300
2	540312	tap head 1/4"		
3	547427	handle red/blue		



fig.	order no.	T	ø(mm)	A(mm)	B1(mm)	B2(mm)	rotation angle	suitable for
1	542005	1/2"	18	105	130	70	360°	universal
1	540950	1/2"	18	105	130	70	90°	universal
1	540360	1/2"	18	105	165	110	360°	universal
1	540669	1/2"	20	105	140	55	90°	universal
1	540361	3/4"	18	110	165	110	360°	universal
1	540362	3/4"	18	110	210	150	90°	universal
2	514214	1/2"	20	90	175	135	360°	Giga



no.	order no.	description	suitable for	ref. no.
1	540709	mixer tap	Mareno Mareno Gico	450100 422106 450114



fig.	order no.	T	ø(mm)	A(mm)	B1(mm)	B2(mm)	rotation angle	suitable for
1	547900	1/2"	18	155	115	150	360°	universal
1	547901	1/2"	18	200	240	170	360°	universal
1	547902	1/2"	18	250	290	220	360°	universal
2	547903	1/2"	18	200	215	150	360°	universal
2	547904	1/2"	18	250	240	175	360°	universal
2	547905	1/2"	18	300	270	205	360°	universal



fig.	order no.	description	suitable for	ref. no.
1	514336	mixer tap with flange (no spout and hoses)	Icos	I10000
2	514395	mixer tap with spout and hoses	universal	

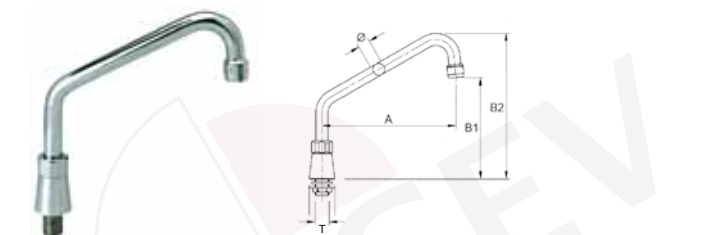

no.	order no.	T	ø(mm)	A(mm)	B1(mm)	B2(mm)	rotation angle	suitable for
1	547906	1/2"	18	200	240	175	360°	universal
2	547907	1/2"	18	250	260	195	360°	universal
3	547908	1/2"	18	300	290	225	360°	universal



fig.	order no.	T	ø(mm)	A(mm)	B1(mm)	B2(mm)	rotation angle	suitable for
1	514330	3/4"	17	180	165	40	60°	universal
2	540887	3/4"	20	100	110	40	90°	Küppersbusch Ascoblock



fig.	order no.	T	ø(mm)	A(mm)	B1(mm)	B2(mm)	rotation angle	suitable for
1	514332	3/4"	25	200	200	25	360°	Küppersbusch Thielmann
2	540890	3/4"	25	200	245	70	360°	Küppersbusch



fig.	order no.	T	ø(mm)	A(mm)	B1(mm)	B2(mm)	rotation angle	suitable for
1	514406	1/2"	18	105	115	60	90°	Olis
2	540787	1/2"	20	120	165	100	90°	Baron

fixed spouts



fig.	order no.	T	ø(mm)	A(mm)	B1(mm)	B2(mm)	suitable for
1	540940	1/2"	18	95	135	90	Ambach
2	542006	1/2" / 3/8"	16	80	90	40	MBM



fig.	order no.	T	ø(mm)	A(mm)	B1(mm)	B2(mm)	suitable for
1	514401	M16x1.5	10	48	35	15	Mareno
2	514078	3/8"	10	48	46	25	Angelo Po
3	514408	3/8"	12	50	48	25	Olis



fig.	order no.	T	A(mm)	B(mm)	rotation angle	suitable for
1	540705	1/2"	120	55	360°	Emmepi universal
2	540990	1/2"	50	50	fixed	Zanussi
3	540992	1/2" inside	23	23	fixed	Zanussi

inlet heads

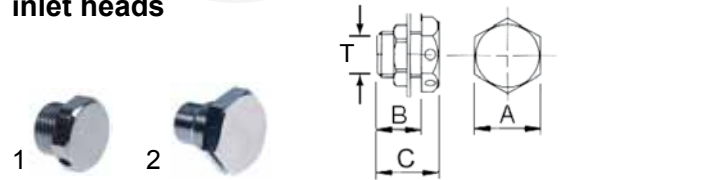

fig.	order no.	T	A(mm)	B(mm)	C(mm)	suitable for
1	693483	1/2"	27	12	20	Emainox
1	693728	1/2"	30	20	28	Nayati
2	691390	3/8" / 1/2"	30	22	29	Baron

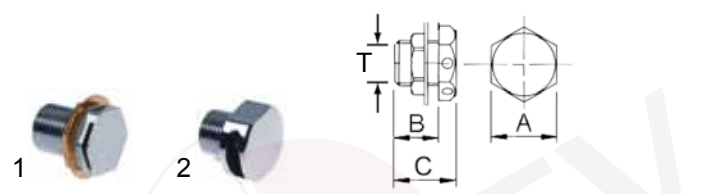

fig.	order no.	T	A(mm)	B(mm)	C(mm)	suitable for
1	691605	1/2"	27	26	32	Lohberger
2	691606	1/2"	34	15	29	universal
2	691607	1/2"	34	20	34	MKN

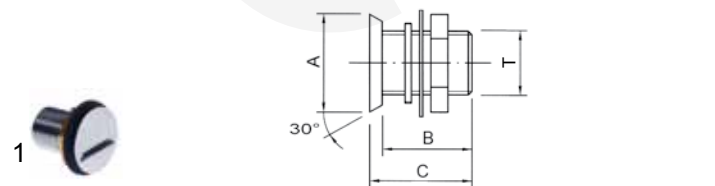

fig.	order no.	T	A(mm)	B(mm)	C(mm)	suitable for
1	691604	1/2"	32	29	33	universal

accessories



fig.	order no.	description	size	fig.	order no.	description	size
1	511469	nut	3/8"	3	511473	flat washer	3/8"
1	511470	nut	1/2"	3	511474	flat washer	1/2"
1	511471	nut	3/4"	3	511475	flat washer	3/4"
2	511472	nut	3/8"	4	511476	gasket	3/8"
2	361184	nut	1/2"	4	511477	gasket	1/2"
2	520234	nut	3/4"	4	511478	gasket	3/4"

steam taps

Echtermann

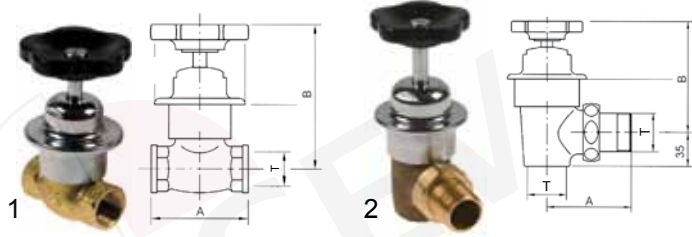

fig.	order no.	T	A(mm)	B(mm)
1	541541	¾"	75	118
1	541542	1"	90	140
1	541543	1¼"	110	148
2	541544	1"	82	136
2	541545	1¼"	95	138

spare parts



fig.	order no.	description	for steam tap
1	541556	tap head 1"	¾"
1	541557	tap head 1¼"	1"
1	541558	tap head 1½"	1¼"
2	541559	handle - ø80(8x8)	¾"
2	540229	handle - ø80(9x9)	1"/1¼"



fig.	order no.	description	for steam tap
1	541550	fiber gasket 1"	¾"
1	541551	fiber gasket 1¼"	1"
1	541552	fiber gasket 1½"	1¼"
2	541553	copper gasket 1"	¾"
2	541554	copper gasket 1¼"	1"
2	541555	copper gasket 1½"	1¼"
3	541547	teflon gasket	¾"
3	541548	teflon gasket	1"
3	541549	teflon gasket	1¼"
4	541561	shaft gasket	¾"
4	541562	shaft gasket	1"/1¼"
5	541546	screw	

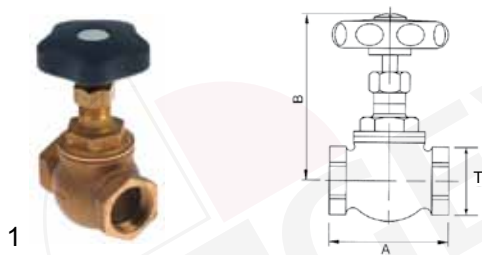

no.	order no.	T	A(mm)	B(mm)
1	541454	1"	80	115
2	541599	1¼"	95	135



fig.	order no.	T	A(mm)	B(mm)
1	520000	1¼"	52	190
2	541455	1"	40	150



fig.	order no.	description	fig.	order no.	description
1	541565	tap head 1"	3	541563	handle 1" ø72/7x7
1	541566	tap head 1¼"	3	541567	handle 1¼" ø72/9x9
2	541564	teflon gasket 1"			

anti-vacuum valves



fig.	order no.	T	A(mm)	fig.	order no.	T	A(mm)
1	540013	¾"	78	2	540015	¾"	90
1	540014	½"	78	2	540016	½"	90

O-ring sealing



fig.	order no.	T	A(mm)	B(mm)	fig.	order no.	T	A(mm)	B(mm)
1	540010	¾"	22	22	2	540012	¾"	30	25
2	540949	½"	22	15					

metallic sealing



fig.	order no.	T	A(mm)	B(mm)	fig.	order no.	T	A(mm)	B(mm)
1	540824	¼"	19	29	3	540011	½"	22	51
1	540826	½"	24	42	4	540827	¾"	--	61
2	540825	¾"	24	45					

metallic sealing (special edition)



fig.	order no.	T	A(mm)	B(mm)	suitable for
1	541428	3/4"	30	25	MKN
2	541430	1/2"	22	27	MKN

test taps

male connection



fig.	order no.	T	A(mm)	B(mm)	suitable for
1	540818	1/2"	87	40	universal
2	540632	1/2"	50	35	Angelo Po

female connection

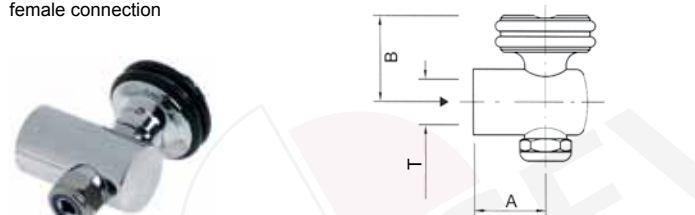

fig.	order no.	T	A(mm)	B(mm)	suitable for
1	540080	3/8"	27.5	33	universal



fig.	order no.	T	A(mm)	B(mm)	suitable for
1	540206	3/8"	75	20	universal
2	514277	3/8"	69	26	universal

with funnel

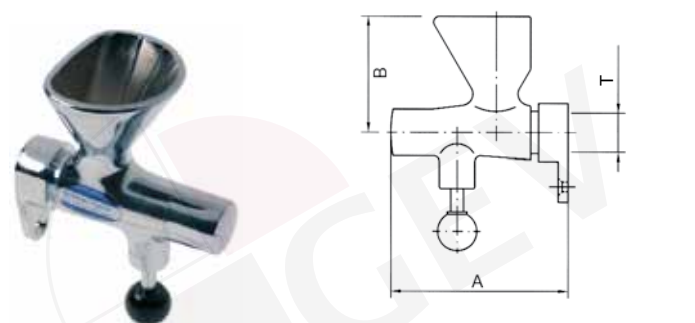

fig.	order no.	T	A(mm)	B(mm)	suitable for
1	540079	1/2"	94	60	universal

safety fittings

Echtermann



fig.	order no.	blow-off pressure(bar)	connection	manometer thread
1	514111	0.4	1"	1/4" / 1/2"
1	514110	0.5	1"	1/4" / 1/2"
2	514327	0.4	1"	1/4" / 1/2"
2	514274	0.5	1"	1/4" / 1/2"



no.	order no.	blow-off pressure(bar)	connection	manometer thread
1	514113	0.4	1"	1/4" / 1/2"
2	514114	0.5	1"	1/4" / 1/2"



fig.	order no.	blow-off pressure(bar)	connection	manometer thread
1	514112	0.4	1"	1/4" / 1/2"
1	540920	0.5	1"	1/4" / 1/2"
2	514328	0.4	1"	1/4" / 1/2"

spare parts



fig.	order no.	description	thread
1	540011	anti-vacuum valves	1/2"
2	540949	anti-vacuum valves	1/2"



fig.	order no.	description	thread
1	540926	filling pot	3/8"
2	540322	ball handle	M6
2	540075	ball handle	M5

Rubinerie del Friuli



fig.	order no.	blow-off pressure(bar)	connection
1	514382	0.5	3/4"
2	540744	0.5	1 1/4"



fig.	order no.	blow-off pressure(bar)	connection
1	514381	0.5	1 1/4"



fig.	order no.	blow-off pressure(bar)	connection
1	514275	0.45	3/4"
2	514404	0.45	3/4"



fig.	order no.	blow-off pressure(bar)	connection
1	514276	0.45	3/4"
2	514123	0.45	3/4"
3	514124	0.45	3/4"

spare parts



fig.	order no.	description	thread
1	540822	fitting holder	3/4"
2	540816	fitting holder	1 1/4"



fig.	order no.	description	thread
1	540820	fitting holder	1 1/4"
2	540821	fitting holder	1 1/4"

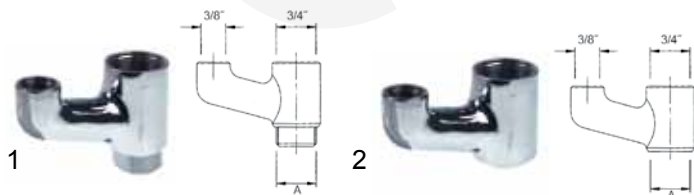

fig.	order no.	description	A	fig.	order no.	description	A
1	540832	Y-piece	3/8"	1	540860	Y-piece	3/4"
1	540817	Y-piece	1/2"	2	540633	Y-piece	1/2"

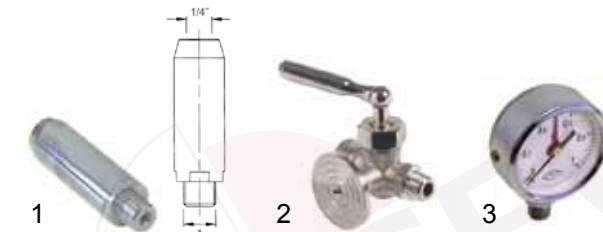

fig.	order no.	description	A
1	540828	manometer syphon	3/8"
1	540829	manometer syphon	1/2"
2	540830	manometer tap	1/4"
3	541062	manometer tap	1/4"



fig.	order no.	description	thread
1	540833	screw cap	3/8"
1	540834	screw cap	1/2"
1	540835	screw cap	3/4"
2	514094	angle	3/8"



fig.	order no.	description	thread
1	540824	anti-vacuum valves	1/4"
1	540826	anti-vacuum valves	1/2"
2	540825	anti-vacuum valves	3/8"
3	540827	anti-vacuum valves	3/4"



no.	order no.	description	thread
1	514122*	safety valve 0.5bar	3/4"
2	540823	safety valve 0.5bar	3/4"
3	514121*	safety valve 0.5bar	1 1/4"
4	540721	safety valve 0.5bar	1 1/4"

*with CE-approval



no.	order no.	description	thread
1	540836	filling pot with ball valve	1/2"
2	541501	reducer	3/4" ET / 1/4" inside

built in safety fittings Echtermann

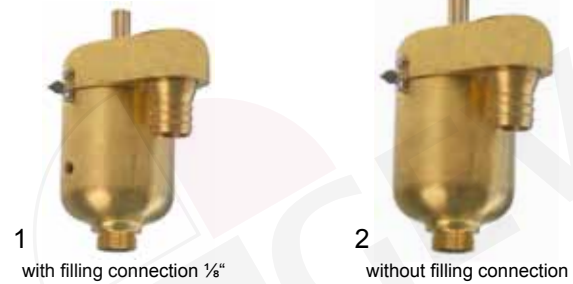

fig.	order no.	blow-off pressure (bar)	thread	fig.	order no.	blow-off pressure (bar)	thread
1	514115	0.4	3/4"	2	514117	0.4	3/4"
1	514116	0.5	3/4"	2	540921	0.5	3/4"

safety fittings with lid Echtermann



fig.	order no.	set pressure (bar)	thread
1	514118	0.4	1 1/2"
2	540882	0.5	1 1/2"



fig.	order no.	set pressure(bar)	thread
1	514119	0.4	1 1/4"

Rubinetterie del Friuli



fig.	order no.	description	suitable for
1	540722	lid safety valve with output	universal
2	510406	gasket	universal
3	514415	lid safety valve without output	Firex
4	541597	lid safety valve with output	Fagor

safety valves

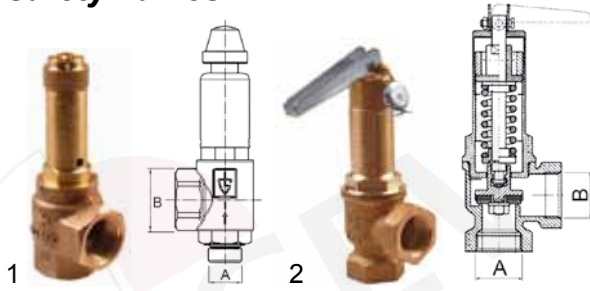

fig.	order no.	set pressure	A(mm)	B(mm)	product
1	514273	0.65bar	½"	½"	Herose
1	514353	0.60bar	¾"	¾"	Herose
1	101977	0.65bar	¾"	¾"	Herose
1	514354	0.50bar	1"	1"	Herose
2	540909	0.50bar	½"	½"	Paracchini

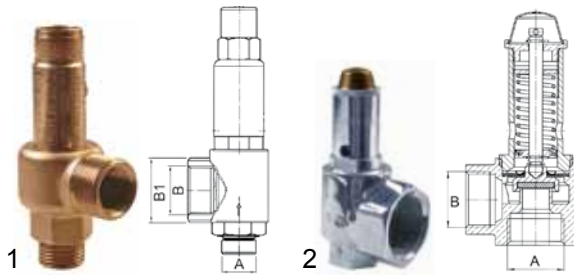
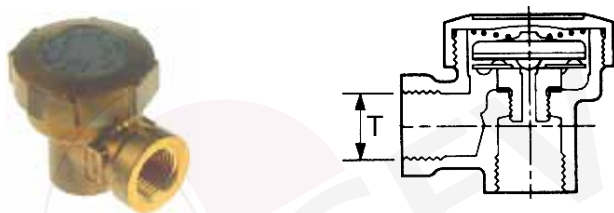

fig.	order no.	set pressure	A(mm)	B(mm)	B1(mm)	product
1	540708	0.50bar	½"	½"	¾"	GI
2	540880	0.50bar	½"	1"		Götze
2	540923	0.50bar	½"	1"		Götze
2	541357	1.25bar	½"	1"		Götze



fig.	order no.	set pressure	A(mm)	B(mm)	product
1	541431	1.0bar	½"	1"	SYR
1	540915	1.1bar	½"	1"	SYR
2	540881	0.65bar	¾"	1"	SYR
2	514071	1.1bar	¾"	1"	SYR
2	541458	1.3bar	¾"	1"	SYR

steam traps



no.	order no.	T	type
1	540784	½"	BPT13A(E)
2	540779*	½"	BPT13AX(E)
3	540994	¾"	BPT13A(E)

*with conical protective strainer

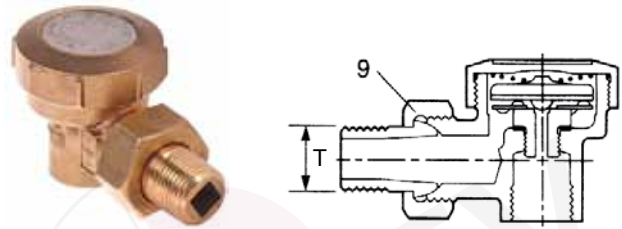

no.	order no.	T	type
1	540243	½"	BPT13UA(E)
2	540244	¾"	BPT13UA(E)

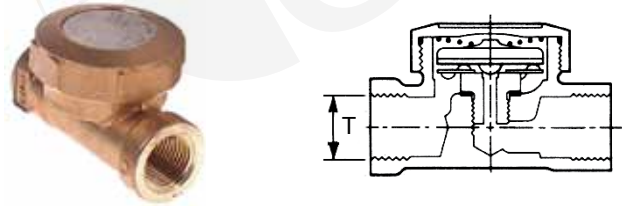

no.	order no.	T	type
1	541461	½"	BPT13S(E)
2	541571	¾"	BPT13S(E)

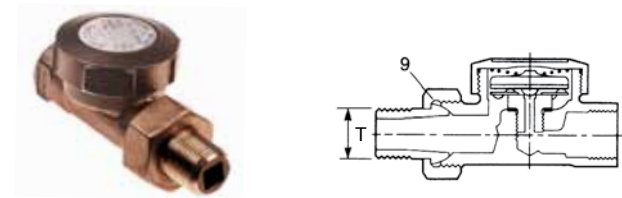

no.	order no.	T	type
1	541572	½"	BPT13US(E)
2	541573	¾"	BPT13US(E)



no.	order no.	T	type
1	540223	½"	TSS21



no.	order no.	T	type
1	541356	½"	ST 1730

spare parts



no.	order no.	size	type
1	540219	1/2"-3/4"	BPT13(E)

no.	order no.	size	type
1	541574*	1/2"-3/4"	BPT13...X(E)

*with conical protective strainer

automatic steam trap

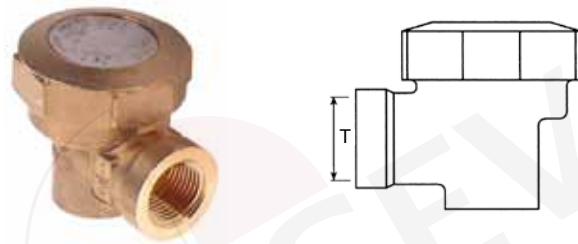

fig.	order no.	T	type
1	514272	1/2"	AV13

lid hinges

Echtermann

key

Echtermann part no. **6910.01/45-3-80**

serial number

serial number subassembly
(fixing)

level of centre of rotation (H)

lifting capacity range
(stamped on every hinge)

read angle

lifting capacity range

series 6910 series 6912 series 6914	1	to approx. 10 Nm	6	approx. 50 Nm - 60 Nm
	2	approx. 10 Nm - 20 Nm	7	approx. 70 Nm - 100 Nm
	3	approx. 20 Nm - 30 Nm	8	approx. 40 Nm - 60 Nm
	5	approx. 30 Nm - 50 Nm		
	series 6911	1	approx. 100 Nm - 140 Nm	3
2		approx. 140 Nm - 200 Nm		

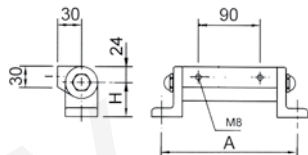

no.	order no.	Echtermann part no.	A (mm)	suitable for	reference no.
1	540876	6910.84/45-2-75	198	Küppersbusch	131627
2	700196	6910.84/45-5-75	198	Küppersbusch	134372
3	700198	6910.84/45-6-75	198	Küppersbusch	134373
4	690848	6910.88/45-7-80	220	Küppersbusch	154400

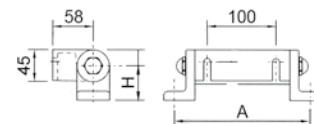

no.	order no.	Echtermann part no.	A (mm)	suitable for	reference no.
1	691203	6910.81/45-6-75	198	Therma Electrolux	716045136 OK5247
2	691204	6910.82/35-7-75	220	Therma Electrolux	716045137 0H9913
3	693214	6910.82/35-7-87	220	Küppersbusch	134357

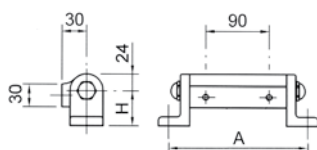

no.	order no.	Echtermann part no.	A (mm)	suitable for	reference no.
1	693505	6912.84/35-2-80	198	MKN	207160
2	693506	6912.84/35-3-80	198	MKN	207180
3	693507	6912.84/35-5-80	198	MKN	207174
4	693508	6912.84/35-6-80	198	MKN	207015
5	693447	6912.84/35-5-80	198	Küppersbusch Thielmann	144138

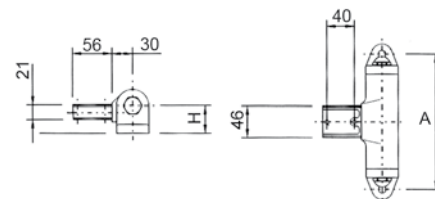

for square pipes
50x25x2mm

no.	order no.	Echtermann part no.	A (mm)	suitable for	reference no.
1	693241	6910.61/35-3-60	198	Juno Electrolux	275792 275793 OK2589
2	693242	6910.61/35-5-60	198	Juno Electrolux	275793 OK2589
3	693246	6910.61/35-6-60	198	Juno Electrolux	275796 OK2591

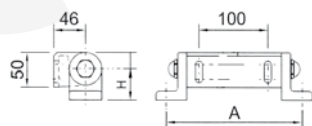

no.	order no.	Echtermann part no.	A (mm)	suitable for	reference no.
1	693448	6910.80/45-6-80	198	Küppersbusch Thielmann	144466

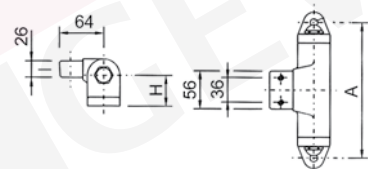

for square pipes
60x30x2mm

no.	order no.	Echtermann part no.	A (mm)	suitable for	reference no.
1	693240	6910.62/45-1-75	198	Juno Electrolux	275787 OK2586
2	693234	6910.62/45-2-75	198	Juno Electrolux	275788 OK2587
3	693235	6910.62/45-3-75	198	Juno Electrolux	275789 0H6887
4	693237	6910.62/45-5-75	198	Juno Electrolux	275791 OK2588
5	693245	6910.62/45-6-75	198	Juno Electrolux	275800 OK2593

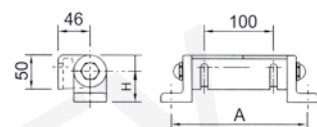

no.	order no.	Echtermann part no.	A (mm)	suitable for	reference no.
1	693236	6910.86/40-3-75	198	Juno Electrolux	275785 OK2585
2	693238	6910.86/65-3-75	198	Juno Electrolux	275801 OK2594
3	693239	6910.86/65-3-75	198	Juno Electrolux	275802 OK2595

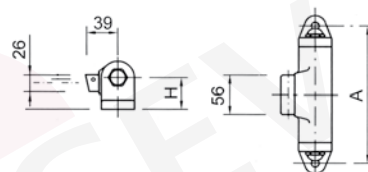

no.	order no.	Echtermann part no.	A (mm)	suitable for	reference no.
1	693449	6912.63/40-3-80	198	Küppersbusch Thielmann	144701
2	693450	6912.63/40-5-80	198	Küppersbusch Thielmann	144122

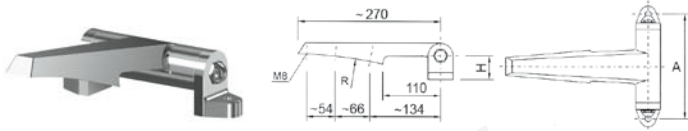

no.	order no.	Echtermann part no.	R (mm)	A (mm)	suitable for	reference no.
1	693502	6910.71/32-2-80	585	198	MKN	207175
2	693503	6910.72/35-2-80	800	198	MKN	207170
3	693504	6910.73/35-3-80	1200	198	MKN	207171

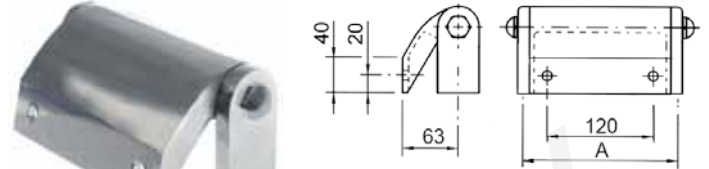

no.	order no.	Echtermann part no.	A (mm)	suitable for	reference no.
1	693212	6910.91/75-3-87	175	Küppersbusch	131624



no.	order no.	Echtermann part no.	A (mm)	suitable for	reference no.
1	690850	6911.81/116-2-90	220	Küppersbusch	154401
2	690851	6911.81/116-3-90	220	Küppersbusch	133701 133761
3	690849	6911.81/116-4-90	220	Küppersbusch	131620



no.	order no.	Echtermann part no.	A (mm)	B (mm)	suitable for	reference no.
1	700199	6910.11/72-6-80	198	490	Küppersbusch	134360



no.	order no.	Echtermann part no.	A (mm)	suitable for	reference no.
1	693216	6911.80/66-2-90	340	Küppersbusch	131930
2	693217	6911.80/66-3-90	340	Küppersbusch	131931

spare parts

for series 6910/6912



no.	order no.	lifting capacity range	no.	order no.	lifting capacity range
1	691610	1	4	691613	5
2	691611	2	5	691614	6
3	691612	3			

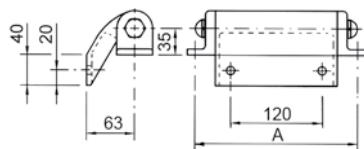

no.	order no.	Echtermann part no.	A (mm)	suitable for	reference no.
1	693213	6910.89/35-3-87	214	Küppersbusch	131608
2	693215	6910.89/35-7-87	214	Küppersbusch	131609

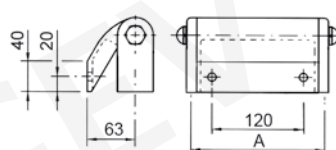

no.	order no.	Echtermann part no.	A (mm)	suitable for	reference no.
1	693211	6910.92/35-7-87		Küppersbusch	131619

fig.	order no.	lifting capacity range
1	691615	7

Icos



fig.	order no.	description	R (mm)
1	514131	hinge body	320
1	514132	hinge body	395
1	514133	hinge body	500
1	514134	hinge body	545
2	514136	holder	



fig.	order no.	description	fig.	order no.	description
1	514129	setting bush	3	540855	spring left 5mm
2	514137	spring guide	3	514349	spring right 6mm
3	514339	spring right 4mm	3	514350	spring left 6mm
3	514346	spring left 4mm	3	514351	spring right 6.5mm
3	540854	spring right 5mm	3	514352	spring left 6.5mm



fig.	order no.	description
1	514135	bracket handle



fig.	order no.	description
1	514341	hinge support left
1	514340	hinge joint support right
2	514342	support cover
3	514128	spacer bushing
4	514343	setting bush
5	514352	spring left
5	514351	spring right

Firex



no.	order no.	description	R (mm)
1	514412	lid hinge, spring thickness 4mm	320
2	514413	lid hinge, spring thickness 5mm	395
3	514414	lid hinge, spring thickness 6mm	470

spare parts



no.	order no.	description	no.	order no.	description
1	540847	spring right 4 mm	4	540855	spring left 5 mm
2	540846	spring left 4 mm	5	540856	spring right 6 mm
3	540854	spring right 5 mm	6	540857	spring left 6 mm

various



no.	order no.	description	suitable for
1	700395	lid hinge, with handle spring thickness 7 mm	MBM



fig.	order no.	description	R(mm)	suitable for
1	700034	lid hinge, spring thickness 3 mm	220	GICO
2	700035	lid hinge, spring thickness 5 mm	320	GICO

lid locks (Autoclave)



fig.	order no.	description	suitable for	reference no.
1	514164	hinge body	Fagor	X156101
2	514169	swivel joint support	Fagor	X286102



fig.	order no.	description	suitable for	reference no.
1	514162	hinge body	Fagor	S036130
2	514168	swivel joint support	Fagor	S036131



fig.	order no.	description	suitable for	reference no.
1	514165	setting bush	Fagor	S116120
2	691727	bearing	Fagor	S116118
3	691016	spring 5.6 mm	Fagor	S116121
4	514167	bush	Fagor	S116126
5	514166	bearing	Fagor	S116119

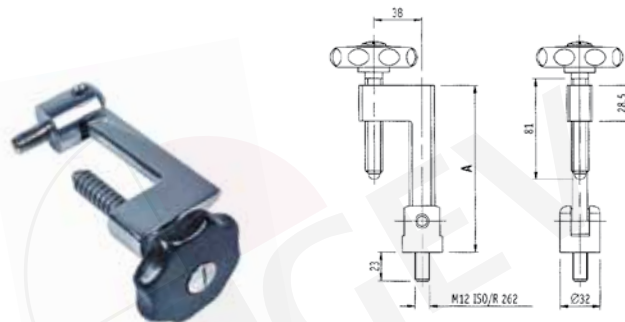

no.	order no.	A (mm)	no.	order no.	A (mm)
1	514125	123	3	540851	143
2	540850	134			

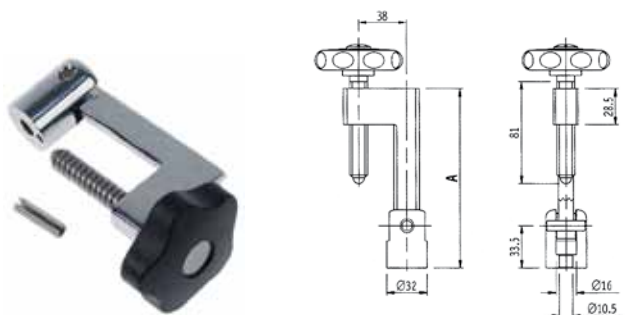

no.	order no.	A (mm)	no.	order no.	A (mm)
1	514126	123	2	514127	143



fig.	order no.	description	suitable for	ref. no.
1	900510	lid gasket 2 m	Icos	
1	900513	lid gasket 2.5 m	Icos	
1	900514	lid gasket 3.2 m	Icos	
1	900515	lid gasket 3.5 m	Icos	
2	900819	lid gasket 1 m	Firex	
2	900821	lid gasket 2 m	Firex	
2	900822	lid gasket 2.4 m	Firex	
2	900823	lid gasket 3m	Firex	

Notes

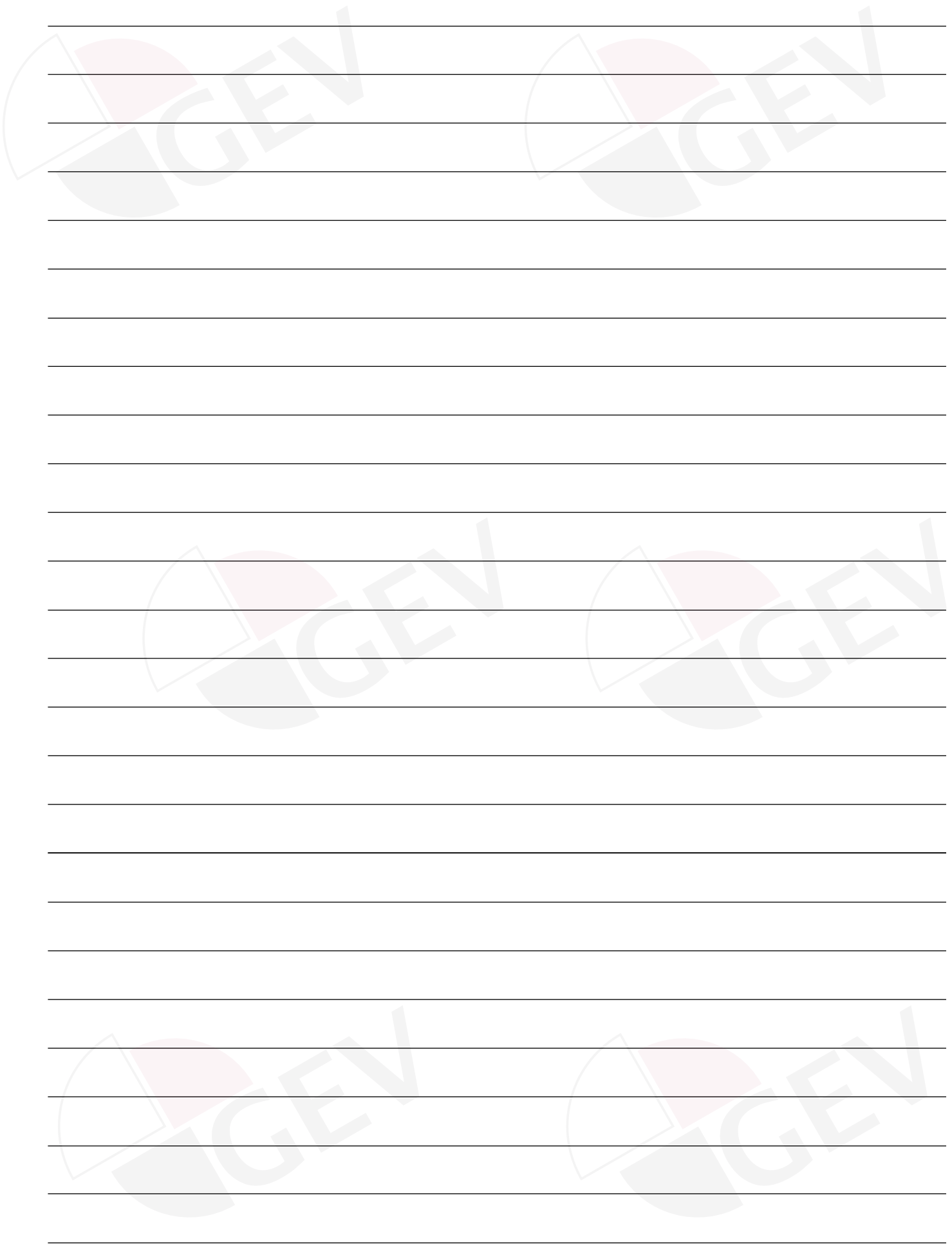

A series of horizontal lines for writing notes, with a large, faint watermark logo consisting of a pink and grey semi-circle and the text 'IGEV' repeated diagonally across the page.